



904-29 Ave  
Nisku, Alberta  
Canada T9E 1B7

T. 1-780-955-9344  
F. 1-780-955-9343

[www.customvac.com](http://www.customvac.com)



# Parts Catalogue



# Table Of Contents

<b>1.0 <a href="#">Valves</a></b>	
1.1 Betts Valves	<a href="#">Page 5</a>
1.2 Metaltecnica Valves & Parts	<a href="#">Pages 6-10</a>
1.3 Misc. Valves & Gaskets	<a href="#">Pages 11-19</a>
<b>2.0 <a href="#">Filters</a></b>	<a href="#">Pages 20-21</a>
<b>3.0 <a href="#">Seals &amp; Tank Parts</a></b>	
3.1 Door Seals	<a href="#">Page 22</a>
3.2 Misc. Seals & Tank Parts	<a href="#">Pages 23-28</a>
<b>4.0 <a href="#">Vacuum Blowers</a></b>	
4.1 Hibon	<a href="#">Page 29</a>
4.2 Robuschi	<a href="#">Page 30</a>
<b>5.0 <a href="#">Vacuum Pumps</a></b>	
5.1 Fruitland Pumps	<a href="#">Page 31</a>
<b>6.0 <a href="#">Wash Cabinet Parts</a></b>	
6.1 Cat Pumps & Parts	<a href="#">Pages 32-34</a>
6.2 Wash Hose & Accessories	<a href="#">Pages 35-39</a>
6.3 Ripsaw Nozzles & Kits	<a href="#">Page 40</a>
6.4 Dig Tubes & Accessories	<a href="#">Pages 41-42</a>
6.5 Cabinet & Burner Parts	<a href="#">Pages 43-48</a>
<b>7.0 <a href="#">Hose &amp; Camlocks</a></b>	
7.1 Product Hose	<a href="#">Pages 49-50</a>
7.2 Hose Clamps	<a href="#">Page 51</a>
7.3 Aluminum Camlocks	<a href="#">Pages 52-57</a>
7.4 Stainless Steel Camlocks	<a href="#">Pages 58-60</a>
<b>8.0 <a href="#">Lights &amp; Electrical</a></b>	<a href="#">Pages 61-69</a>
<b>9.0 <a href="#">Boom Parts</a></b>	
9.1 Radio Systems	<a href="#">Page 70</a>
9.2 Boom Swivels	<a href="#">Page 71</a>
9.3 Boom Cylinders & Parts	<a href="#">Page 72-74</a>
9.4 Worm Gears	<a href="#">Page 75</a>

<b>10.0 <a href="#">Deck Box &amp; Cabinet Hardware</a></b>	<b><a href="#">Pages 76-81</a></b>
<b>11.0 <a href="#">Power Take-Offs</a></b>	<b><a href="#">Pages 82-83</a></b>
<b>12.0 <a href="#">Agitators</a></b>	<b><a href="#">Pages 84-86</a></b>
<b>13.0 <a href="#">Hydraulics</a></b>	
<b>13.1 Pumps &amp; Motors</b>	<b><a href="#">Pages 87-88</a></b>
<b>13.2 Coolers &amp; Fans</b>	<b><a href="#">Pages 89-91</a></b>
<b>13.3 Hydraulic Filters</b>	<b><a href="#">Pages 92-93</a></b>
<b>13.4 Vibrators</b>	<b><a href="#">Page 94</a></b>
<b>13.5 Joysticks</b>	<b><a href="#">Pages 95-96</a></b>
<b>13.6 Hydraulic Cylinders</b>	<b><a href="#">Pages 97-98</a></b>
<b>13.7 Magnaloy Couplers</b>	<b><a href="#">Pages 99-101</a></b>
<b>13.8 Sun Cartridges</b>	<b><a href="#">Pages 102-104</a></b>
<b>14.0 <a href="#">Hydraulic Fittings</a></b>	
<b>14.1 <a href="#">Adapters</a></b>	
<b>14.1.1 JIC</b>	<b><a href="#">Pages 105-106</a></b>
<b>14.1.2 JIC to FNPT</b>	<b><a href="#">Pages 107-108</a></b>
<b>14.1.3 JIC to NPT</b>	<b><a href="#">Pages 109-111</a></b>
<b>14.1.4 JIC to ORB</b>	<b><a href="#">Pages 112-114</a></b>
<b>14.1.5 FNPT to NPT</b>	<b><a href="#">Page 115</a></b>
<b>14.1.6 FNPT to ORB</b>	<b><a href="#">Page 116</a></b>
<b>14.1.7 JIC to FLANGE</b>	<b><a href="#">Pages 117-118</a></b>
<b>14.2 <a href="#">45° Adapters</a></b>	
<b>14.2.1 JIC</b>	<b><a href="#">Page 119</a></b>
<b>14.2.2 JIC to NPT</b>	<b><a href="#">Page 120</a></b>
<b>14.2.3 JIC to ORB</b>	<b><a href="#">Pages 121-122</a></b>
<b>14.2.4 JIC to FLANGE</b>	<b><a href="#">Pages 123-124</a></b>
<b>14.3 <a href="#">90° Adapters</a></b>	
<b>14.3.1 JIC</b>	<b><a href="#">Page 125</a></b>
<b>14.3.2 JIC to NPT</b>	<b><a href="#">Pages 126-127</a></b>
<b>14.3.3 JIC to ORB</b>	<b><a href="#">Pages 128-129</a></b>

<b>14.4 <a href="#">Bulkheads</a></b>	
14.4.1 JIC	<a href="#">Page 130</a>
14.4.2 JIC to FNPT	<a href="#">Page 131</a>
14.4.3 JIC to NPT	<a href="#">Page 132</a>
<b>14.5 <a href="#">90° Bulkheads</a></b>	
14.5.1 JIC	<a href="#">Page 133</a>
<b>14.6 <a href="#">Bushings</a></b>	
14.6.1 FNPT to NPT	<a href="#">Pages 134-135</a>
<b>14.7 <a href="#">Couplings</a></b>	
14.7.1 FNPT	<a href="#">Page 136</a>
<b>14.8 <a href="#">Elbows</a></b>	
14.8.1 JIC	<a href="#">Pages 137-141</a>
14.8.2 FNPT	<a href="#">Page 142</a>
14.8.3 FNPT to NPT	<a href="#">Page 143</a>
14.8.4 NPT	<a href="#">Page 144</a>
14.8.5 JIC to FLANGE	<a href="#">Pages 145-146</a>
<b>14.9 <a href="#">Nipples</a></b>	
14.9.1 NPT	<a href="#">Page 147</a>
<b>14.10 <a href="#">Reducers</a></b>	
14.10.1 ORB to FORB	<a href="#">Page 148</a>
<b>14.11 <a href="#">Tees</a></b>	
14.11.1 JIC	<a href="#">Pages 149-151</a>
14.11.2 JIC to NPT	<a href="#">Pages 152-153</a>
14.11.3 JIC to ORB	<a href="#">Pages 154-156</a>
14.11.4 NPT	<a href="#">Pages 157-158</a>
<b>14.12 <a href="#">Unions</a></b>	
14.12.1 JIC	<a href="#">Page 159</a>
<b>15.0 <a href="#">Aluminum Slide-in Tanks</a></b>	<a href="#">Pages 160-161</a>

# 1.1 BETTS VALVES



Description	Part Number
4" BETTS PISTON GATE VALVE W/ACTUATOR	SV764MSTSJ
6" BETTS PISTON GATE VALVE W/ACTUATOR	SV766MSTSJ
4" BETTS PISTON GATE VALVE	SV764MSTSJ008
6" BETTS PISTON GATE VALVE	SV766MSTSJ008
BETTS AIR ACTUATOR - 4" & 6"	47191ALB

## 1.2 METALTECNICA VALVES & ACCESSORIES



Description	Part Number
4" BRASS LEVER GATE VALVE	ARZO 0031 100 000
6" BRASS LEVER GATE VALVE	ARZO 0031 150 000



Description	Part Number
4" BRASS LEVER GATE VALVE W/HEAT COLLAR	ARZO 0033 100 000
6" BRASS LEVER GATE VALVE W/HEAT COLLAR	ARZO 0033 150 000

## 1.2 METALTECNICA VALVES & ACCESSORIES



Description	Part Number
4" BRASS PISTON GATE VALVE	ARZO 0041 100 000
4" BRASS PISTON GATE VALVE	ARZO 0041 150 000



Description	Part Number
4" BRASS PISTON GATE VALVE W/ HEAT COLLAR	ARZO 0043 100 000
6" BRASS PISTON GATE VALVE W/ HEAT COLLAR	ARZO 0043 150 000

## 1.2 METALTECNICA VALVES & ACCESSORIES



Description	Part Number
8" BRASS FLANGED PISTON GATE VALVE	ARZO 0074 200 000
8" PISTON GATE VALVE LEVER	ARZO 0930 200 000



Description	Part Number
4" AIR OPEN/SPRING CLOSE ACTUATOR	ARZO 0580 100 000
6" AIR OPEN/SPRING CLOSE ACTUATOR	ARZO 0580 150 000

## 1.2 METALTECNICA VALVES & ACCESSORIES



Description	Part Number
2" HEAT COLLAR RING	0232
4" HEAT COLLAR RING	0234
6" HEAT COLLAR RING	0235



Description	Part Number
2" HEAT COLLAR ASSEMBLY	2HCSC80
4" HEAT COLLAR ASSEMBLY	0230
6" HEAT COLLAR ASSEMBLY	0231

## 1.2 METALTECNICA VALVES & ACCESSORIES



Description	Part Number
4" BRASS REPLACEMENT GATE	FOZO 0040 100 002
6" BRASS REPLACEMENT GATE	FOZO 0040 150 002



Description	Part Number
1-1/2" VACUUM BREAK VALVE	ARZO 0811 040 000
2" BRASS PRESSURE RELIEF VALVE	ARZO 0871 050 000

### 1.3 MISC. VALVES & GASKETS



Description	Part Number
6" WAFER CHECK VALVE	DC700E600
8" WAFER CHECK VALVE	DC700E800
12" WAFER CHECK VALVE	DC700E1200



Description	Part Number
6" 4-WAY VALVE	1488102100
8" 4-WAY VALVE	1488100500

## 1.3 MISC. VALVES & GASKETS



Description	Part Number
3" RING GASKET	3150BAU125
4" RING GASKET	4150BAU125
6" RING GASKET	6150BAU125
8" RING GASKET	8150BAU125
12" RING GASKET	12150BAU125

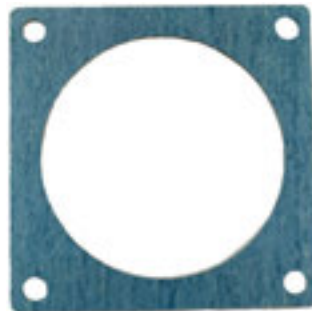

Description	Part Number
6" 4-WAY GASKET	64WAYBAU
8" 4-WAY GASKET	84WAYBAU

### 1.3 MISC. VALVES & GASKETS



Description	Part Number
2" CHALLENGER BUTTERFLY VALVE W/AIR ACTUATOR	80864
4" CHALLENGER BUTTERFLY VALVE W/AIR ACTUATOR	80866
6" CHALLENGER BUTTERFLY VALVE W/AIR ACTUATOR	80083
8" CHALLENGER BUTTERFLY VALVE W/AIR ACTUATOR	80918

### 1.3 MISC. VALVES & GASKETS



Description	Part Number
2" NPT BAYCO 14.9 PSI RELIEF VALVE	A2182-M-14.9



Description	Part Number
2" 15 PSI KUNKLE VALVE	0337-H01AKM0015

### 1.3 MISC. VALVES & GASKETS



Description	Part Number
AIR PILOT MAC VALVE	1800011120003



Description	Part Number
12V PILOT MAC VALVE	811CPM62CC152
110V PILOT MAC VALVE	811CPM112CC152

### 1.3 MISC. VALVES & GASKETS

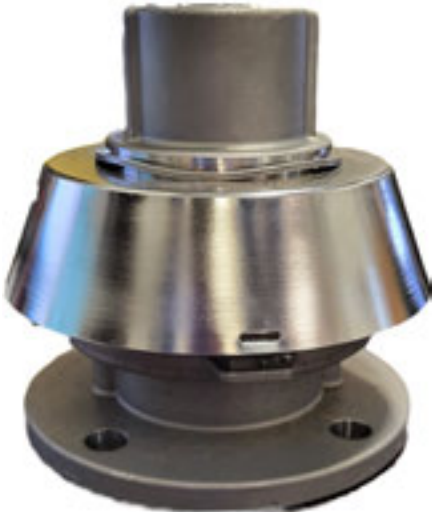

Description	Part Number
3" 25 PSI PRESSURE RELIEF VALVE	RVP3AT-25



Description	Part Number
2" VICTAULIC METERING VALVE	VIC020761SE2

### 1.3 MISC. VALVES & GASKETS



Description	Part Number
2-POSITION WILLIAMS AIR SWITCH	WIM118316
3-POSITION WILLIAMS AIR SWITCH	WIM118317



Description	Part Number
QUICK EXHAUST DUMP VALVE	AQ2000N02

## 1.3 MISC. VALVES & GASKETS



Description	Part Number
FLIPPER SWITCH VALVE	KN20001



Description	Part Number
1/2" BRASS BALL VALVE	V202-050
1" BRASS BALL VALVE	V202-100
2" BRASS BALL VALVE	V202-200
2-1/2" BRASS BALL VALVE	V202-250
3" BRASS BALL VALVE	V202-300
4" BRASS BALL VALVE	V202-400
6" BRASS BALL VALVE	V202-600

### 1.3 MISC. VALVES & GASKETS



Description	Part Number
1/2" SS 3000# BALL VALVE	12T23FPBVVT



Description	Part Number
2" SS 1000# BALL VALVE	V412-200

## 2.0 FILTERS - HOW TO MEASURE FILTERS



To help ensure we can provide you with the proper filter to fit your needs please provide us with the following measurements:

- Height
- Outside Diameter
- Inside Diameter



## 2.0 FILTERS



Description	Part Number
5.5" ID X 8" OD X 8.25" H SS FILTER	SPM98090
5.75" ID X 8" OD X 8.25" H FILTER	SPM1104
12.5" ID X 16" OD X 11.5" H FILTER	SPM976
12" ID X 20" OD X 12" H FILTER	SPM1176
12" ID X 20" OD X 18" H FILTER	SPM1009



Description	Part Number
DRY VAC STANDARD BAG	1009285
DRY VAC STANDARD CAGE	1019178

### 3.1 REAR DOOR SEALS



Description	Part Number
21' REAR DOOR SEAL (BUILD DATE UP TO 2018)	153691002
21' REAR DOOR SEAL (BUILD DATE 2019-PRESENT)	RUB015
ADHESIVE SEALANT FOR REAR DOOR SEAL	7100097767



Description	Part Number
1" X 1" D-RUBBER DOOR SEAL	151125266

### 3.2 MISC. SEALS & TANK PARTS



Description	Part Number
5/8" KNIFE GATE SEAT	LVSEATKIT5812BUN
3/4" KNIFE GATE SEAT	LVSEATKIT3412BUN



Description	Part Number
KNIFE GATE TEFLON BRAID PACKING	1152-500

### 3.2 MISC. SEALS & TANK PARTS



Description	Part Number
3/4" QUARTER ROUND RUBBER	151125504
1" QUARTER ROUND RUBBER	ES111000E70
1-1/2" QUARTER ROUND RUBBER	151125546



Description	Part Number
TURBO VAC BOOT	TURBOBOOT

### 3.2 MISC. SEALS & TANK PARTS



Description	Part Number
6" SHUTOFF BALL SEAT	160020005



Description	Part Number
6" STOP BALL	ARZO 0920 150 000
8" STOP BALL	ARZO 0920 200 000
12" STOP BALL	FB12SS

### 3.2 MISC. SEALS & TANK PARTS



Description	Part Number
1/2" FLOAT ARM	12FLOATARM



Description	Part Number
6" FLOAT BALL W/HOLE	ARZO 0921 150 000

### 3.2 MISC. SEALS & TANK PARTS



Description	Part Number
TANK FLOAT BUSHING	FLOATBUSHING



Description	Part Number
FLOAT BUSHING TEFLON PACKING KIT	TEFLON

### 3.2 MISC. SEALS & TANK PARTS



Description	Part Number
FLOAT INDICATOR ARM - DRIVER SIDE	300089
FLOAT INDICATOR ARM - PASS SIDE	300088



Description	Part Number
INDICATOR ARM BUSHING	INDBUSHING

## 4.1 HIBON VACUUM BLOWERS



Description	Part Number
HIBON 820VS BLOWER	HIB820VS
HIBON 822XL BLOWER	HIB822XL



Description	Part Number
4L JAR OF ISO 220 BLOWER OIL	5EP20-4L

**\* REBUILT BLOWERS CAN BE PURCHASED OR EXCHANGED.  
PLEASE CALL FOR DETAILS**

## 4.2 ROBUSCHI VACUUM BLOWERS



Description	Part Number
ROBUSCHI RBDV85	RBDV85



Description	Part Number
ROBUSCHI RBDV145	RBDV145

\* REBUILT BLOWERS CAN BE PURCHASED OR EXCHANGED.  
PLEASE CALL FOR DETAILS

# 5.1 FRUITLAND PUMPS



Description	Part Number
FRUITLAND 870 TOP MOUNT CCW PUMP	RCF870LUFH



Description	Part Number
FRUITLAND 1200 TOP MOUNT CCW PUMP	RCF1200LUH

**\* REBUILT PUMPS CAN BE PURCHASED OR EXCHANGED.  
PLEASE CALL FOR DETAILS**

# 6.1 CAT PUMPS & PARTS



Description	Part Number
CAT 660 PLUNGER PUMP	CA660



Description	Part Number
CAT 3560 PLUNGER PUMP	CA3560

# 6.1 CAT PUMPS & PARTS



Description	Part Number
CAT PUMP OILER	CA30278



Description	Part Number
CAT 660 CERAMIC PLUNGER	CA43300
CAT 3560 CERAMIC PLUNGER	CA48535

# 6.1 CAT PUMPS & PARTS



Description	Part Number
CAT 660 SEAL KIT	CA30798
CAT 3560 SEAL KIT	CA31280



Description	Part Number
CAT 660 VALVE KIT	CA30820
CAT 3560 VALVE KIT	CA31292

## 6.2 WASH HOSE & ACCESSORIES



Description	Part Number
3/8" X 100' STEAM/WASH HOSE ASSEMBLY	119H-06MM100
3/8" X 100' BLUE SOAP/CHEM HOSE ASSEMBLY	119B-06MLM100
1/2" X 100' WASH HOSE ASSEMBLY	114CC-08MLML100

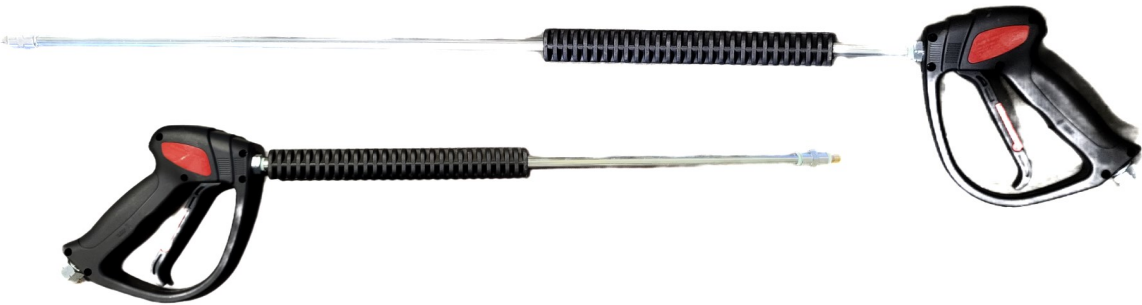

Description	Part Number
36" LANCE WASH WAND	HTEC1206-6.5
24" LANCE SOAP WAND	HTEC1300-FOAM

# 6.2 WASH HOSE & ACCESSORIES



Description	Part Number
1/4" #8 MEG NOZZLE	ZZ2508B
1/4" #12 MEG NOZZLE	ZZ2512B



Description	Part Number
1/2" WATER BLAST TIP MALE	FD69100288
V1/2" WATER BLAST TIP FEMALE	FD69100188

## 6.2 WASH HOSE & ACCESSORIES



Description	Part Number
3/8" FARLEY 36" STEAM WAND	BP1136
3/8" NPT FARLEY STEAM NOZZLE	BP1772



Description	Part Number
5' STEEL DIG WAND W/#8 RIPS AW	HTEC1857-08WAND
5' STEEL DIG WAND EXTENSION	HTEC10272

## 6.2 WASH HOSE & ACCESSORIES



Description	Part Number
3/8" MALE HAWK QUICK NIPPLE	HO826292
1/2" MALE HAWK QUICK NIPPLE	HO826295



Description	Part Number
3/8" FEMALE HAWK QUICK NIPPLE	HO826290
1/2" FEMALE HAWK QUICK NIPPLE	HO826294

## 6.2 WASH HOSE & ACCESSORIES



Description	Part Number
3/8" MALE HAWK QUICK COUPLER	HO826302
1/2" MALE HAWK QUICK COUPLER	HO826305



Description	Part Number
3/8" FEMALE HAWK QUICK COUPLER	HO826300
1/2" FEMALE HAWK QUICK COUPLER	HO826304

### 6.3 RIPSAW NOZZLES & KITS



Description	Part Number
#4 RIPSAW HD NOZZLE	1002719040
#6 RIPSAW HD NOZZLE	1002719060
#8 RIPSAW HD NOZZLE	1002719080
#10 RIPSAW HD NOZZLE	1002719100
#4 RIPSAW NOZZLE REPAIR KIT	1001858040
#6 RIPSAW NOZZLE REPAIR KIT	1001858060
#8 RIPSAW NOZZLE REPAIR KIT	1001858080
#10 RIPSAW NOZZLE REPAIR KIT	1001858100

# 6.4 DIG TUBES & ACCESSORIES



Description	Part Number
6" X 6' PVC DIG TUBE	DIGTUBEPVC6X6
6" X 6' PVC DIG TUBE EXTENSION	DIGTUBEPVCEXT6X6
6" X 6' ALUMINUM DIG TUBE	DIGTUBEHW6
6" X 6' ALUMINUM DIG TUBE EXTENSION	DIGTUBEHWEXT

# 6.4 DIG TUBES & ACCESSORIES



Description	Part Number
6" V-GROVE VACTOR CLAMP	G71C-600
8" V-GROVE VACTOR CLAMP	G71C-800



Description	Part Number
8" - 6" REDUCER FLANGE	G71FF-800-600

# 6.4 CABINET & BURNER PARTS



Description	Part Number
12V 1.3GPM SHURFLO SOAP PUMP	SH8000-542-296



Description	Part Number
12V 15 PSI GLYCOL BOOSTER PUMP	34308
GLYCOL BOOSTER REPAIR KIT	34308-KIT

\* REPAIR KIT INCLUDES O-RING, MECHANICAL SEAL AND MOTOR  
 ADDITIONAL PARTS AVAILABLE, PLEASE CALL FOR DETAILS

# 6.4 CABINET & BURNER PARTS



Description	Part Number
0-250 THERMOCOUPLE PROBE	BPASP0580



Description	Part Number
375 DEG HIGH LIMIT SWITCH	KA8753847

# 6.4 CABINET & BURNER PARTS



Description	Part Number
3/8" SAFETY RELIEF VALVE	GE100534



Description	Part Number
3/8" 4000 PSI FLOW SWITCH	GE103011

# 6.4 CABINET & BURNER PARTS



Description	Part Number
1/2" FMPT 90 DEG SUPER SWIVEL	HR401404



Description	Part Number
NON-ADJUSTABLE RELIEF VALVE	AD7438

# 6.4 CABINET & BURNER PARTS



Description	Part Number
F17A GREY THERMOSTAT CONTROLLER	BPBTC702



Description	Part Number
F72B BLACK THERMOSTAT CONTROLLER	BPBTC702200

# 6.4 CABINET & BURNER PARTS



Description	Part Number
FIRE EYE W/30" LEAD	BP13666



Description	Part Number
3.00 80 DEG FUEL NOZZLE	BP30080W

## 7.1 PRODUCT HOSE



Description	Part Number
1-1/4" OIL & GAS HOSE	G643-125
1-1/2" OIL & GAS HOSE	G643-150
2" OIL & GAS HOSE	G643-200
3" OIL & GAS HOSE	G643-300
4" OIL & GAS HOSE	G643-400
6" OIL & GAS HOSE	G643-600
8" OIL & GAS HOSE	G643C-800
12" OIL & GAS HOSE	G643C-1200

## 7.1 PRODUCT HOSE



Description	Part Number
8" X 32' BOOM HOSE	MT70-800-32



Description	Part Number
2" X 4' VIC END LOOP HOSE	CP30-200GG4
6" X 7.5' VIC END LOOP HOSE	CP30-600GG7.5
8" X 8' VIC END LOOP HOSE	CP30-800GG8

## 7.2 HOSE CLAMPS



Description	Part Number
1-1/4" SS T-BOLT CLAMP	G89-026
1-1/2" SS T-BOLT CLAMP	G89-030
2" SS T-BOLT CLAMP	G89-038
3" SS T-BOLT CLAMP	G89-054
4" SS T-BOLT CLAMP	G92-112121
6" SS T-BOLT CLAMP	G92-162174
8" SS T-BOLT CLAMP	G92-213226
8-1/2" SS T-BOLT CLAMP	G92-226239
10" SS T-BOLT CLAMP	M10DC260
12" SS T-BOLT CLAMP	M10DC325K

## 7.3 ALUMINUM CAMLOCKS



Description	Part Number
2" ALUMINUM PART A CAMLOCK	G65A-200
3" ALUMINUM PART A CAMLOCK	G65A-300
4" ALUMINUM PART A CAMLOCK	G65A-400
6" ALUMINUM PART A CAMLOCK	G65A-600
8" ALUMINUM PART A CAMLOCK	G65A-800
4" ALUMINUM PART A SWIVEL CAMLOCK	G65AX-400
6" ALUMINUM PART A SWIVEL CAMLOCK	G65AX-600

### 7.3 ALUMINUM CAMLOCKS



Description	Part Number
2" ALUMINUM PART F CAMLOCK	G65F-200
3" ALUMINUM PART F CAMLOCK	G65F-300
4" ALUMINUM PART F CAMLOCK	G65F-400
6" ALUMINUM PART F CAMLOCK	G65F-600
8" ALUMINUM PART F CAMLOCK	G65F-800

### 7.3 ALUMINUM CAMLOCKS



Description	Part Number
2" ALUMINUM PART B CAMLOCK	G66LB-200
3" ALUMINUM PART B CAMLOCK	G66LB-300
4" ALUMINUM PART B CAMLOCK	G66LB-400
6" ALUMINUM PART B CAMLOCK	G66LB-600

### 7.3 ALUMINUM CAMLOCKS



Description	Part Number
2" ALUMINUM PART D CAMLOCK	G66LD-200
3" ALUMINUM PART D CAMLOCK	G66LD-300
4" ALUMINUM PART D CAMLOCK	G66LD-400
6" ALUMINUM PART D CAMLOCK	G66LD-600

## 7.3 ALUMINUM CAMLOCKS



Description	Part Number
2" ALUMINUM DUST CAP	G66LDC-200
3" ALUMINUM DUST CAP	G66LDC-300
4" ALUMINUM DUST CAP	G66LDC-400
6" ALUMINUM DUST CAP	G66LDC-600
8" ALUMINUM DUST CAP	ALDC800

### 7.3 ALUMINUM CAMLOCKS



Description	Part Number
2" ALUMINUM DUST PLUG	G65DP-200
3" ALUMINUM DUST PLUG	G65DP-300
4" ALUMINUM DUST PLUG	G65DP-400
6" ALUMINUM DUST PLUG	G65DP-600
8" ALUMINUM DUST PLUG	G65DP-800

## 7.4 STAINLESS STEEL CAMLOCKS



Description	Part Number
2" STAINLESS PART A CAMLOCK	G65SSA-200
3" STAINLESS PART A CAMLOCK	G65SSA-300
4" STAINLESS PART A CAMLOCK	G65SSA-400
6" STAINLESS PART A CAMLOCK	G65SSA-600



Description	Part Number
2" STAINLESS PART F CAMLOCK	G65SSF-200
3" STAINLESS PART F CAMLOCK	G65SSF-300
4" STAINLESS PART F CAMLOCK	G65SSF-400
6" STAINLESS PART F CAMLOCK	G65SSF-600

## 7.3 STAINLESS STEEL CAMLOCKS



Description	Part Number
4" STAINLESS PART D CAMLOCK	G66SSLD-400
6" STAINLESS PART D CAMLOCK	G66SSLD-600



Description	Part Number
3" STAINLESS DUST PLUG	G65SSDP-300
4" STAINLESS DUST PLUG	G65SSDP-400

## 7.3 STAINLESS STEEL CAMLOCKS



Description	Part Number
2" STAINLESS DUST CAP	G65SSLDC-200
3" STAINLESS DUST CAP	G65SSLDC-300
4" STAINLESS DUST CAP	G65SSLDC-400
6" STAINLESS DUST CAP	G65SSLDC-600

**\*BRASS CAMLOCKS ARE ALSO AVAILABLE  
PLEASE CALL FOR DETAILS**

## 8.0 LIGHTS & ELECTRICAL



Description	Part Number
2.5" AMBER CLEAR LENS LED MARKER LAMP	LED2500C-13A



Description	Part Number
2.5" RED CLEAR LENS LED MARKER LAMP	LED2500C-13R

## 8.0 LIGHTS & ELECTRICAL

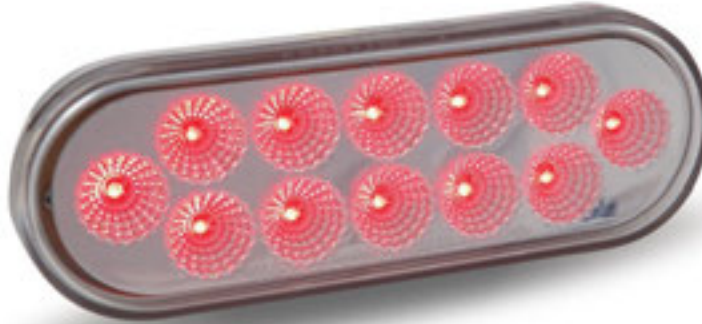

Description	Part Number
OVAL S/T/T & B/U LED MARKER LAMP	TLED-OX60R



Description	Part Number
4.5" W X 5" H LED WORK LIGHT	LW4262

# 8.0 LIGHTS & ELECTRICAL



Description	Part Number
2-1/2" ROUND GROMMET	GR2501



Description	Part Number
MODEL 60 OVAL GROMMET	GR2238

## 8.0 LIGHTS & ELECTRICAL



Description	Part Number
5.38" X 6" HD LED WORK LAMP	LW5353



Description	Part Number
12V INTERIOR DOME LIGHT	TL 80251C

## 8.0 LIGHTS & ELECTRICAL



Description	Part Number
21" XL LED CURVED LIGHT BAR	54-32408
13-1/4" LED LIGHT BAR	200130



Description	Part Number
5" CHROME BASE DOME LIGHT	80350

## 8.0 LIGHTS & ELECTRICAL



Description	Part Number
12" LED LIGHT STRIP	LDS06127S-1
20" LED LIGHT STRIP	LDS06207S-1



Description	Part Number
3000W PURE SINE WAVE 12V INVERTER	100030

## 8.0 LIGHTS & ELECTRICAL



Description	Part Number
12V MODEL 100 CAB HEATER	7000101
12V MODEL 200 CAB HEATER	7000202



Description	Part Number
RED DOT 12V AUXILIARY CAB HEATER	R2900P

## 8.0 LIGHTS & ELECTRICAL



Description	Part Number
6" X 50' ANTI-STATIC GROUND REEL	200650



Description	Part Number
MAIN ELECTRICAL BOX ASSEMBLY	MAINBOXASSY

## 8.0 LIGHTS & ELECTRICAL



Description	Part Number
REAR COLOUR HEAT/CMOS CAMERA	PSOC122H
7" COLOUR LCD MONITOR	PSOM130C
35' CAMERA CABLE FOR WASH CAB	PSORRC35
70' CAMERA CABLE ROR TANK REAR	PSORRC70

## 9.1 RADIO SYSTEMS



Description	Part Number
OMNEX COMPLETE RADIO SYSTEM	ASYS2489293



Description	Part Number
OMNEX 10 BUTTON REMOTE	T110C001062

## 9.2 BOOM SWIVELS



Description	Part Number
3-1/2" H BOOM SWIVEL	71000002



Description	Part Number
BOOM SWIVEL SEAL KIT	71000003

### 9.3 BOOM CYLINDERS & PARTS



Description	Part Number
OLD STYLE BOOM SIDE CYLINDER	6100009



Description	Part Number
VIPER BOOM SIDE CYLINDER	6100009V

### 9.3 BOOM CYLINDERS & PARTS



Description	Part Number
4" X 18" BOOM AIR CYLINDER	02000030



Description	Part Number
4" X 17" VIPER BOOM AIR CYLINDER	02000030A

### 9.3 BOOM CYLINDERS & PARTS



Description	Part Number
PLUNGER ROCK PLATE WITH 3/4" HOLE	51006374



Description	Part Number
VIPER PLUNGER ROCK PLATE WITH 1-3/8"	51006374A

## 9.4 WORM GEARS



Description	Part Number
10" WORM GEAR	10WDS
10" WORM GEAR WITH MOTOR	10WDSH
13" WORM GEAR	13WDS
13" WORM GEAR WITH MOTOR	13WDSH

## 10.0 DECK BOX & CABINET HARDWARE



Description	Part Number
CHROME WHALE TAIL RH HANDLE	200030



Description	Part Number
POMMIER RECESSED SS LATCH	200112

## 10.0 DECK BOX & CABINET HARDWARE



Description	Part Number
VERTICAL DECK BOX HARDWARE KIT	300365
2-DOOR DECK BOX HARDWARE KIT	300366
1-DOOR DECK BOX HARDWARE KIT	300373
3-DOOR DECK BOX HARDWARE KIT	300374
4-DOOR DECK BOX HARDWARE KIT	300375
REAR SKIRT FITTING BOX HARDWARE KIT	300376
VARSOL BOX HARDWARE KIT	300379

**\*HARDWARE KITS INCLUDE HANDLES, HINGES, WEATHER STRIPPING AND MOUNTING HARDWARE.**

## 10.0 DECK BOX & CABINET HARDWARE



Description	Part Number
SPRING LOADED DOOR HOLD BACK LATCH	200042



Description	Part Number
8" SS STRAP HINGE	200031

## 10.0 DECK BOX & CABINET HARDWARE



Description	Part Number
5" SS STRAP HINGE	200128

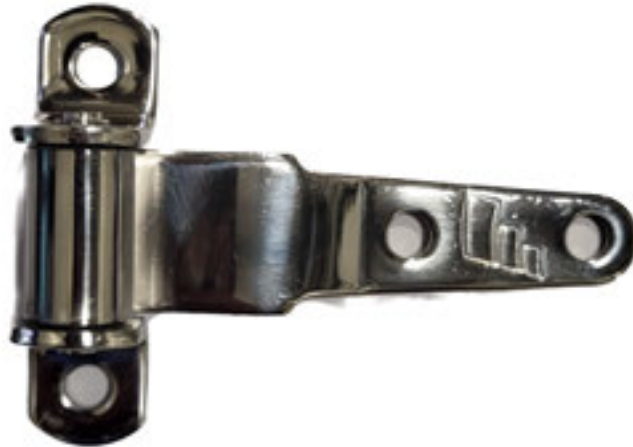

Description	Part Number
3.69" SS STRAP HINGE	200132

## 10.0 DECK BOX & CABINET HARDWARE



Description	Part Number
1.5" X 1.5" SS COUNTERSUNK HINGE	200134

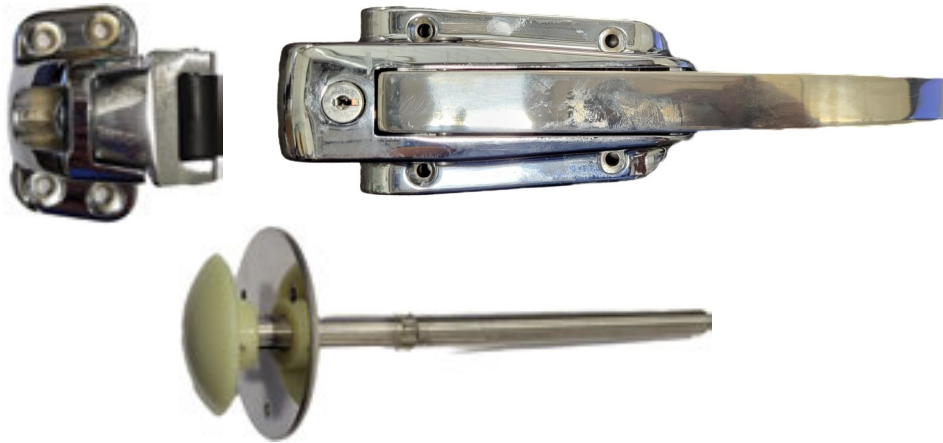

Description	Part Number
REFRIGERATOR HANDLE STRIKER	709-0243
11-18" L REFRIGERATOR OUTSIDE HANDLE	709-0067
REFRIGERATOR INSIDE RELEASE HANDLE	709-0095

## 10.0 DECK BOX & CABINET HARDWARE



Description	Part Number
HORIZONTAL WEATHER STRIPPING	200036
VERTICAL WEATHER STRIPPING	200220
D-STYLE ADHESIVE WEATHER STRIPPING	200121

## 11.0 POWER TAKE-OFFS



Description	Part Number
MUNCIE 8-BOLT PTO DS SWING	828S-U6815-R1EG-MUN
MUNCIE 8-BOLT PTO PS SWING	828S-U6815-R3EG-MUN



Description	Part Number
MUNCIE 6-BOLT PTO	TG6S-U6808-P1BX-PTO
MUNCIE 6-BOLT PTO ADAPTER	40TU6845-1-PTO

## 11.0 POWER TAKE-OFFS

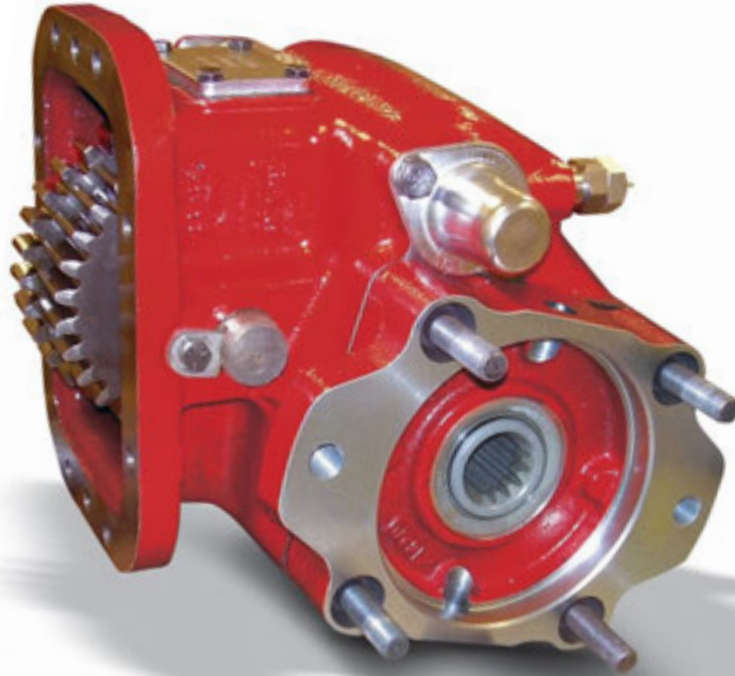

Description	Part Number
CHELSEA 8-BOLT PTO DS SWING	CHL 823XRAHX A3GS
CHELSEA 8-BOLT PTO PS SWING	CHL 823XRAHX A5GS

## 12.0 AGITATORS

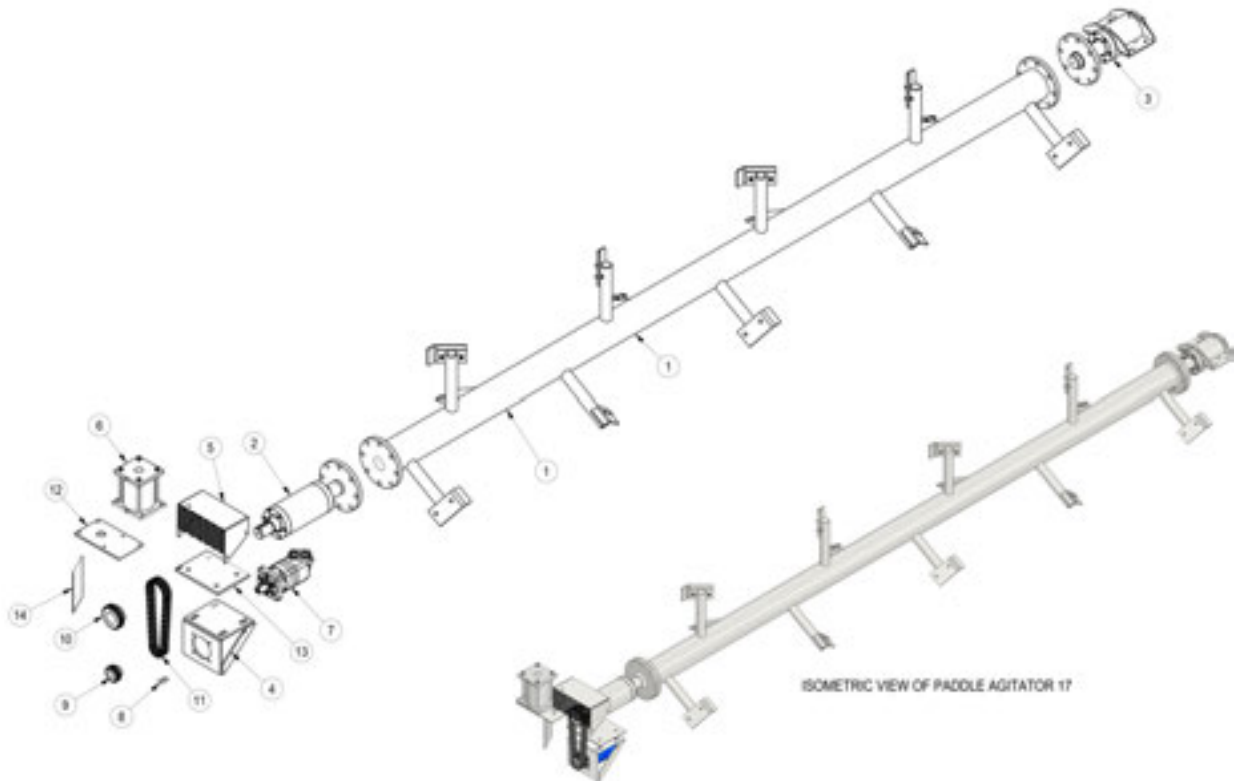

**BOM OF PADDLE AGITATOR FULL ASSEMBLY**

ITEM	DESCRIPTION	QTY	PART #
1	MIXER SHAFT FULL ASSEMBLY	1	A09417NEW
2	BEARING DRIVE FULL SUB-ASSEMBLY	1	300153
3	BEARING IDLER FULL SUB-ASSEMBLY	1	300154
4	HYDRAULIC MOTOR SUB-ASSEMBLY	1	N/A
5	DRIVE GUARD SUB-ASSEMBLY	1	N/A
6	OIL POT RESERVOIR ASSEMBLY	1	THP6X6FFMR
7	CHAR-LYNN HYDR MOTOR 6K EATON ASSEMBLY	1	EAT_1121067006
8	ROLLER CHAIN CONNECTING LINK	1	602OFF
9	SPROCKET B HUB DOUBLE BOR 13 TOOTH	1	D60B13F1B112
10	SPROCKET B HUB DOUBLE BOR 36 TOOTH	1	D60B36F2B212
11	ROLLER CHAIN DOUBLE STRAND ASSEMBLY	1	602RIV
12	OIL RESERVOIR MOUNT PLATE	1	200185
13	MOTOR MOUNT PLATE	1	200181
14	STEEL FLAT BAR	1	10568

## 12.0 AGITATORS



BOM OF BEARING DRIVE ASSEMBLY			
ITEM	DESCRIPTION	QTY	PART #
1	DRIVE AXLE FULL SUB-ASSEMBLY	1	A004
2	DRIVE BEARING HOUSING MECH TUBING	1	RDT001
3	BEARING HOUSING SPACER RING	2	RD008
4	BEARING HOUSING THRU CAP	2	RD009
5	NTN BEARING ASSEMBLY	2	UELS215
6	NATIONAL IND SEAL #416654	4	416654
7	O-RING INCH	2	N70250
8	INTERNAL RETAINING RING #5000-400	2	5000400
9	HEX HEAD BOLT	12	N/A
10	HELICAL SPRING LOCK WASHER	12	N/A

## 12.0 AGITATORS

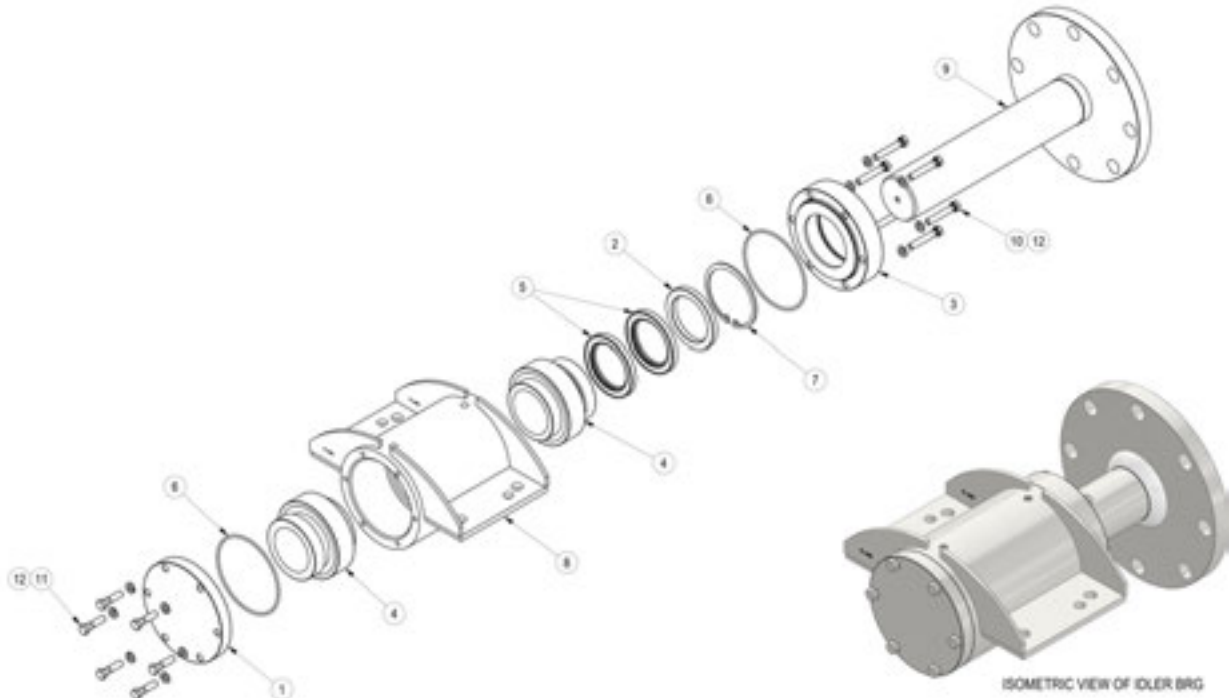

BOM OF BEARING IDLER ASSEMBLY			
ITEM	DESCRIPTION	QTY	PART #
1	IDLER BEARING HOUSING END CAP	1	RD007
2	BEARING HOUSING SPACER RING	1	RD008
3	BEARING HOUSING THRU CAP	1	RD009
4	NTN BEARING ASSEMBLY	2	UELS215
5	NATIONAL IND SEAL #416654	2	416654
6	O-RING INCH	2	N70250
7	INTERNAL RETAINING RING #5000-400	1	5000400
8	IDLER BEARING HOUSING	1	A002
9	IDLER AXLE FULL SUB-ASSEMBLY	1	A005
10	HEX HEAD BOLT	6	N/A
11	HEX HEAD BOLT	6	N/A
12	HELICAL SPRING LOCK WASHER	12	N/A

# 13.1 PUMPS & MOTORS

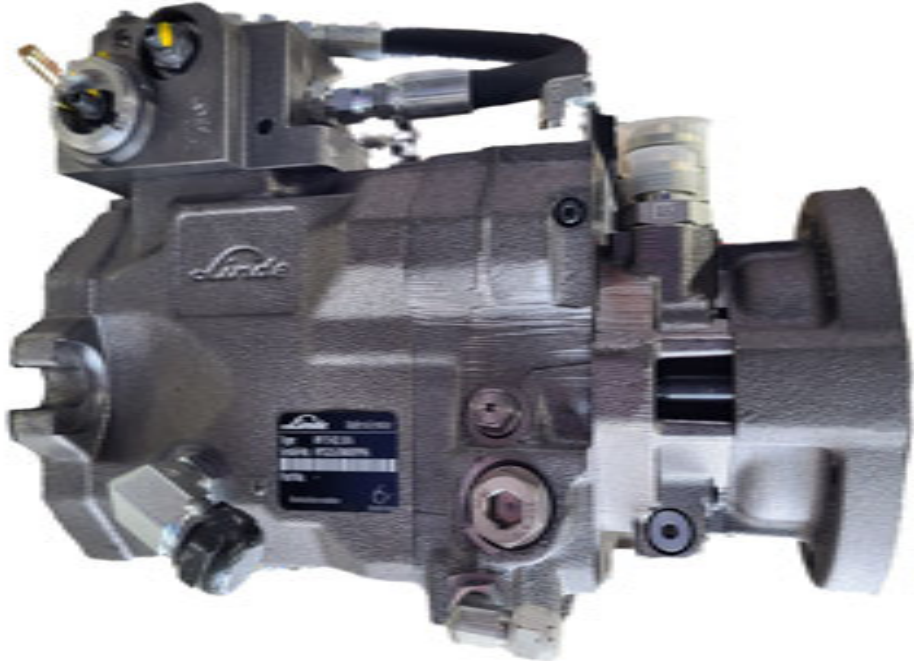

Description	Part Number
LINDE HPV075 PUMP	LIN_2630305
LINDE HPV105 PUMP	LIN_2640402

## 13.1 PUMPS & MOTORS



Description	Part Number
LINDE HMF55 MOTOR	LIN_2920013003
LINDE HMF075 MOTOR	LIN_2930013000



Description	Part Number
MARZOCCHI GHP GEAR PUMP	MAR_GHP3AS66S1FA

## 13.2 COOLERS & FANS



Description	Part Number
AKG 19-3/4" 12V SINGLE OIL COOLER	AKG_DCS2012BP65
AKG 35.4" 12V DUAL OIL COOLER	AKG_DCS6012BP65
THERMAL TRANSFER 12V OIL COOLER	MA-32-2-4A

## 13.2 COOLERS & FANS



Description	Part Number
COOLER FAN FOR AKG DCS20-12 & DCS60-12	84073600076
COOLER FAN FOR TT MA-32	57331
MULTIFIT VA33-AP71/LL-65A COOLER FAN	3010-2082

### 13.2 COOLERS & FANS



Description	Part Number
LED DISPLAY TEMPERATURE CONTROLLER	AKG_TCP1



Description	Part Number
1/2" NPT NASON TEMP SWITCH	HT1C120RHR

### 13.3 HYDRAULIC FILTERS



Description	Part Number
STAUFF CHARGE FILTER ELEMENT	SE030G10B



Description	Part Number
STAUFF RETURN FILTER ELEMENT	RE090G10B4

# 13.3 HYDRAULIC FILTERS

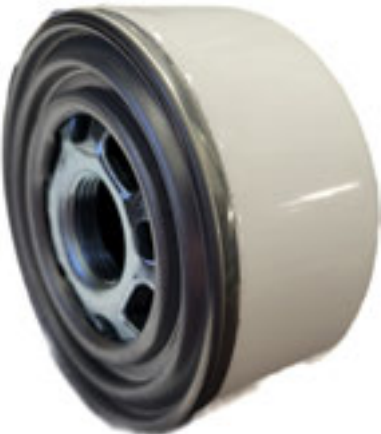

Description	Part Number
STAUFF BREATHER FILTER	SGB9003



Description	Part Number
MP FILTRI FILTER ELEMENT	MF-400-3-P10NB

## 13.4 VIBRATORS



Description	Part Number
C3-6.0 2-BOLT GLOBAL VIBRATOR	532060



Description	Part Number
2HC VIBRATOR HYDRAULIC MOTOR	251020

## 13.5 JOYSTICKS



Description	Part Number
YOU LI JHP-1 JOYSTICK	YOU_JHP11SSAE4FDA04B
JOYSTICK BOOT	YOU_2JHPT001



Description	Part Number
HC-RCM JOYSTICK	05491
JOYSTICK BOOT	87951

# 13.5 JOYSTICKS



Description	Part Number
YOU LI SINGLE MOTOR SPOOL VALVE	YOU_M310202



Description	Part Number
SINGLE AXIS 12V JOYSTICK	OEM_EMS4M12511

## 13.6 HYDRAULIC CYLINDERS



Description	Part Number
KNIFE GATE HYDRAULIC CYLINDER	PC151215
KNIFE GATE CYLINDER SEAL KIT	PC151215SK



Description	Part Number
LOCK DOWN CYLINDER,	D1700039001-G

## 13.6 HYDRAULIC CYLINDERS



Description	Part Number
2" X 10" STROKE CYLINDER	20AGU1010
2" X 12" STROKE CYLINDER	20AGU1210



Description	Part Number
3-1/2" X 12" STROKE CYLINDER	35AGU1210

## 13.7 MAGNALOY COUPLERS

### MAGNALOY COUPLERS GUIDE

The following table details what Magnaloy coupler is on our standard units for blowers, motors and wash pumps.

Item	Coupler Size	Part Number
HIB 820MA BLOWER	42MM X 12MM KEY	M500M4212
HIB 820 XL/VS BLOWER	48MM X 14MM KEY	M500M4814
HIB 822XL/VS BLOWER	65MM X 18MM KEY	M600M6518
ROB RBDV85 BLOWER	55MM X 16MM KET	M500M5516
HMF50/55 BLOWER MOTOR	1-1/4" X 14 T	M500A1412C
HMF75 BLOWER MOTOR	1-1/4" X 14 T	M600A1412C
CAT 660 PUMP	30MM X 8MM KEY	M400M3008
CAT 3560 PUMP	35MM X 10MM KEY	M500M3510
CAT 660 DANFOSS MOTOR	7/8" x 1/4" KEY	M40002808
CAT 3560 HMF75 MOTOR	1-1/4" X 14 T	M500A1412C

## 13.7 MAGNALOY COUPLERS



Description	Part Number
7/8" BORE X 1/4" KEY MAGNALOY COUPLER	M40002808
30MM BORE X 8MM KEY MAGNALOY COUPLER	M400M3008
1-1/4" X 14T-12/24 SP MAGNALOY SPLINE COUPLER	M500A1412C
35MM BORE X 10MM KEY MAGNALOY COUPLER	M500M3510
42MM BORE X 12MM KEY MAGNALOY COUPLER	M500M4212
48MM BORE X 14MM KEY MAGNALOY COUPLER	M500M4814
55MM BORE X 16MM KEY MAGNALOY COUPLER	M500M5516
1-1/4" X 14T-12/24 SP MAGNALOY SPLINE COUPLER	M600A1412C
65MM BORE X 18MM KEY MAGNALOY COUPLER	M600M6518

# 13.7 MAGNALOY COUPLERS



Description	Part Number
470 HYTREL MAGNALOY INSERT	M470H
570 HYTREL MAGNALOY INSERT	M570H
670 HYTREL MAGNALOY INSERT	M670H

## 13.8 SUN CARTRIDGES



Description	Part Number
SUN MANUAL BLOWER CATRIDGE	DWDFLAN



Description	Part Number
12V SUN COIL	740212

# 13.8 SUN CARTRIDGES



Description	Part Number
TORQUE CONTROL SUN CARTRIDGE	RSDCLCN



Description	Part Number
SPEED CONTROL SUN CARTRIDGE	PPDBLEN

## 13.8 SUN CARTRIDGES



Description	Part Number
REMOTE RELIEF SUN CARTRIDGE	RBAEOAN



Description	Part Number
SUN TRI-KNOB KIT	991034

## 14.1.1 HYDRAULIC FITTINGS ADAPTERS - JIC



Description	Part Number
ADAPTER, #4 FJIC X #6 JIC	0515-04-06
ADAPTER, #6 FJIC X #4 JIC	0515-06-04
ADAPTER, #6 FJIC X #8 JIC	0515-06-08
ADAPTER, #8 FJIC X #6 JIC	0515-08-06
ADAPTER, #8 FJIC X #10 JIC	0515-08-10
ADAPTER, #10 FJIC X #8 JIC	0515-10-08
ADAPTER, #12 FJIC X #6 JIC	0515-12-06
ADAPTER, #12 FJIC X #8 JIC	0515-12-08
ADAPTER, #12 FJIC X #16 JIC	0515-12-16

Description	Part Number
ADAPTER, #16 FJIC X #6 JIC	0515-16-06
ADAPTER, #16 FJIC X #8 JIC	0515-16-08
ADAPTER, #16 FJIC X #12 JIC	0515-16-12
ADAPTER, #16 FJIC X #20 JIC	0515-16-20
ADAPTER, #20 FJIC X #12 JIC	0515-20-12
ADAPTER, #20 FJIC X #16 JIC	0515-20-16
ADAPTER, #24 FJIC X #16 JIC	0515-24-16
ADAPTER, #24 FJIC X #20 JIC	0515-24-20

## 14.1.1 HYDRAULIC FITTINGS ADAPTERS - JIC



Description	Part Number
ADAPTER, #4 FJIC X #4 JIC	0515N-04-04
ADAPTER, #6 FJIC X #6 JIC	0515N-06-06
ADAPTER, #8 FJIC X #8 JIC	0515N-08-08
ADAPTER, #12 FJIC X #12 JIC	0515N-12-12
ADAPTER, #16 FJIC X #16 JIC	0515N-16-16

## 14.1.2 HYDRAULIC FITTINGS ADAPTERS - JIC TO FNPT



Description	Part Number
ADAPTER, 1/4" FNPT X #4 FJIC	0508-04-04
ADAPTER, 1/4" FNPT X #6 FJIC	0508-04-06
ADAPTER, 3/8" FNPT X #6 FJIC	0508-06-06
ADAPTER, 1/2" FNPT X #8 FJIC	0508-08-08
ADAPTER, 3/4" FNPT X #12 FJIC	0508-12-12
ADAPTER, 1" FNPT X #16 FJIC	0508-16-16
ADAPTER, 1-1/4" FNPT X #20 FJIC	0508-20-20
ADAPTER, 1-1/2" FNPT X #24 FJIC	0508-24-24

## 14.1.2 HYDRAULIC FITTINGS ADAPTERS - JIC TO FNPT

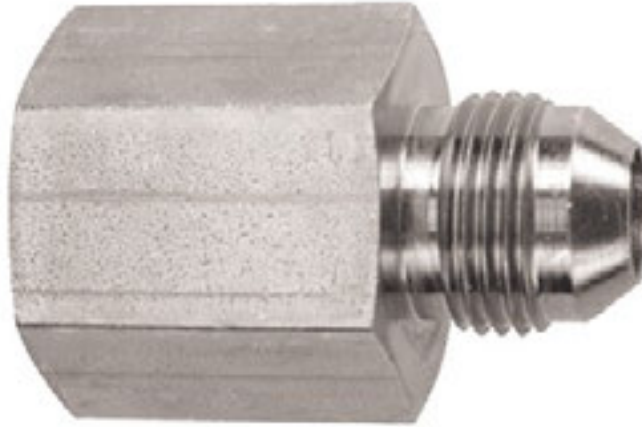

Description	Part Number
ADAPTER, 1/4" FNPT X #4 JIC	1508-04-04
ADAPTER, 1/4" FNPT X #6 JIC	1508-04-06
ADAPTER, 3/8" FNPT X #6 JIC	1508-06-06
ADAPTER, 1/2" FNPT X #8 JIC	1508-08-08
ADAPTER, 1/2" FNPT X #10 JIC	1508-08-10
ADAPTER, 3/4" FNPT X #12 JIC	1508-12-12
ADAPTER, 1" FNPT X #16 JIC	1508-16-16
ADAPTER, 1-1/4" FNPT X #20 JIC	1508-20-20

### 14.1.3 HYDRAULIC FITTINGS ADAPTERS - JIC TO NPT



Description	Part Number
ADAPTER, 1/4" NPT X #4 FJIC	0516-04-04
ADAPTER, 1/4" NPT X #6 FJIC	0516-04-06
ADAPTER, 3/8" NPT X #6 FJIC	0516-06-06
ADAPTER, 1/2" NPT X #8 FJIC	0516-08-08
ADAPTER, 3/4" NPT X #12 FJIC	0516-12-12
ADAPTER, 1" NPT X #16 FJIC	0516-16-16
ADAPTER, 1-1/4" NPT X #20 FJIC	0516-20-20

### 14.1.3 HYDRAULIC FITTINGS ADAPTERS - JIC TO NPT

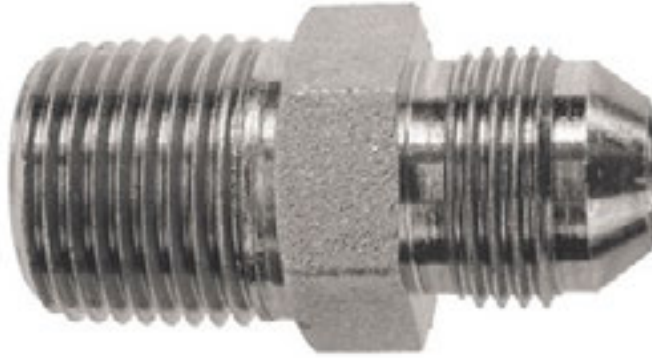

Description	Part Number	Description	Part Number
ADAPTER, 1/8" NPT X #4 JIC	1516-02-04	ADAPTER, 1/2" NPT X #10 JIC	1516-08-10
ADAPTER, 1/4" NPT X #4 JIC	1516-04-04	ADAPTER, 1/2" NPT X #12 JIC	1516-08-12
ADAPTER, 1/4" NPT X #6 JIC	1516-04-06	ADAPTER, 3/4" NPT X #6 JIC	1516-12-06
ADAPTER, 3/8" NPT X #4 JIC	1516-06-04	ADAPTER, 3/4" NPT X #8 JIC	1516-12-08
ADAPTER, 3/8" NPT X #6 JIC	1516-06-06	ADAPTER, 3/4" NPT X #12 JIC	1516-12-12
ADAPTER, 3/8" NPT X #8 JIC	1516-06-08	ADAPTER, 3/4" NPT X #16 JIC	1516-12-16
ADAPTER, 1/2" NPT X #4 JIC	1516-08-04	ADAPTER, 1" NPT X #8 JIC	1516-16-08
ADAPTER, 1/2" NPT X #6 JIC	1516-08-06	ADAPTER, 1" NPT X #12 JIC	1516-16-12
ADAPTER, 1/2" NPT X #8 JIC	1516-08-08	ADAPTER, 1" NPT X #16 JIC	1516-16-16

### 14.1.3 HYDRAULIC FITTINGS ADAPTERS - JIC TO NPT

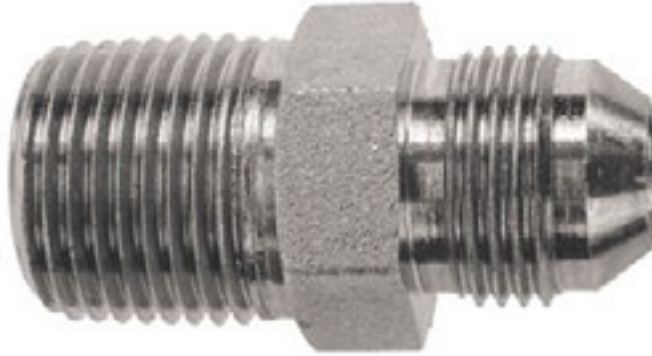

Description	Part Number
ADAPTER, 1-1/4" NPT X #12 JIC	1516-20-12
ADAPTER, 1-1/4" NPT X #16 JIC	1516-20-16
ADAPTER, 1-1/4" NPT X #20 JIC	1516-20-20
ADAPTER, 1-1/2" NPT X #20 JIC	1516-24-20
ADAPTER, 1-1/2" NPT X #24 JIC	1516-24-24

## 14.1.4 HYDRAULIC FITTINGS ADAPTERS - JIC TO ORB



Description	Part Number
ADAPTER, #4 ORB X #4 JIC	1115-04-04
ADAPTER, #4 ORB X #6 JIC	1115-04-06
ADAPTER, #6 ORB X #4 JIC	1115-06-04
ADAPTER, #6 ORB X #6 JIC	1115-06-06
ADAPTER, #6 ORB X #8 JIC	1115-06-08
ADAPTER, #8 ORB X #4 JIC	1115-08-04
ADAPTER, #8 ORB X #6 JIC	1115-08-06
ADAPTER, #8 ORB X #8 JIC	1115-08-08
ADAPTER, #8 ORB X #10 JIC	1115-08-10
ADAPTER, #8 ORB X #12 JIC	1115-08-12
ADAPTER, #10 ORB X #4 JIC	1115-10-04
ADAPTER, #10 ORB X #6 JIC	1115-10-06

Description	Part Number
ADAPTER, #10 ORB X #8 JIC	1115-10-08
ADAPTER, #10 ORB X #10 JIC	1115-10-10
ADAPTER, #10 ORB X #12 JIC	1115-10-12
ADAPTER, #10 ORB X #16 JIC	1115-10-16
ADAPTER, #12 ORB X #6 JIC	1115-12-06
ADAPTER, #12 ORB X #8 JIC	1115-12-08
ADAPTER, #12 ORB X #12 JIC	1115-12-12
ADAPTER, #12 ORB X #16 JIC	1115-12-16
ADAPTER, #16 ORB X #6 JIC	1115-16-06
ADAPTER, #16 ORB X # 8 JIC	1115-16-08
ADAPTER, #16 ORB X #12 JIC	1115-16-12
ADAPTER, #16 ORB X #16 JIC	1115-16-16

## 14.1.4 HYDRAULIC FITTINGS ADAPTERS - JIC TO ORB



Description	Part Number
ADAPTER, #16 ORB X #20 JIC	1115-16-20
ADAPTER, #20 ORB X #12 JIC	1115-20-12
ADAPTER, #20 ORB X #16 JIC	1115-20-16
ADAPTER, #20 ORB X #20 JIC	1115-20-20
ADAPTER, #24 ORB X #16 JIC	1115-24-16
ADAPTER, #24 ORB X #20 JIC	1115-24-20
ADAPTER, #24 ORB X #24 JIC	1115-24-24

## 14.1.4 HYDRAULIC FITTINGS ADAPTERS - JIC TO ORB



Description	Part Number
ADAPTER, #4 ORB X #4 FJIC	0511-04-04
ADAPTER, #6 ORB X #6 FJIC	0511-06-06
ADAPTER, #8 ORB X #8 FJIC	0511-08-08
ADAPTER, #12 ORB X #12 FJIC	0511-12-12
ADAPTER, #16 ORB X #16 FJIC	0511-16-16

## 14.1.5 HYDRAULIC FITTINGS ADAPTERS - FNPT TO NPT

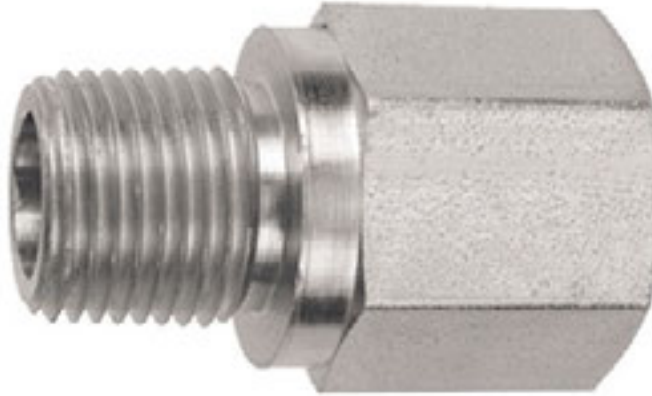

Description	Part Number
ADAPTER, 1/4" NPT X 3/8" FNPT	1608-04-06
ADAPTER, 3/8" NPT X 3/8" FNPT	1608-06-06
ADAPTER, 1/2" NPT X 1/2" FNPT	1608-08-08
ADAPTER, 1/2" NPT X 3/4" FNPT	1608-08-12
ADAPTER, 3/4" NPT X 1" FNPT	1608-12-16
ADAPTER, 1" NPT X 1-1/4" FNPT	1608-16-20

## 14.1.6 HYDRAULIC FITTINGS ADAPTERS - FNPT TO ORB



Description	Part Number
ADAPTER, #4 ORB X 1/4" FNPT	1108-04-04
ADAPTER, #6 ORB X 3/8" FNPT	1108-06-06
ADAPTER, #8 ORB X 1/2" FNPT	1108-08-08
ADAPTER, #12 ORB X 1/2" FNPT	1108-12-08
ADAPTER, #12 ORB X 3/4" FNPT	1108-12-12
ADAPTER, #12 ORB X 1" FNPT	1108-12-16
ADAPTER, #16 ORB X 1" FNPT	1108-16-16
ADAPTER, #20 ORB X 1-1/4" FNPT	1108-20-20
ADAPTER, #24 ORB X 1-1/2" FNPT	1108-24-24

# 14.1.7 HYDRAULIC FITTINGS ADAPTERS - FLANGE TO MALE JIC

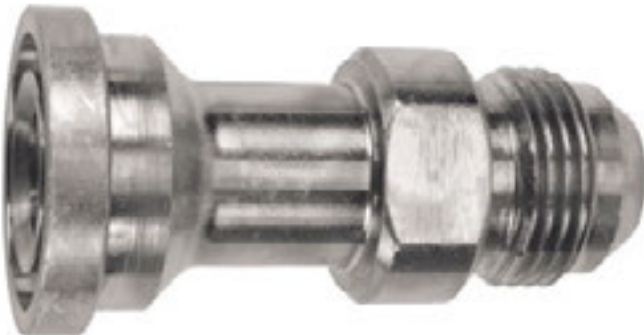

Description	Part Number
ADAPTER, #16 C61 FLG X #16 MJIC STR	0915-16-16

## 14.1.7 HYDRAULIC FITTINGS ADAPTERS - FLANGE TO MALE JIC

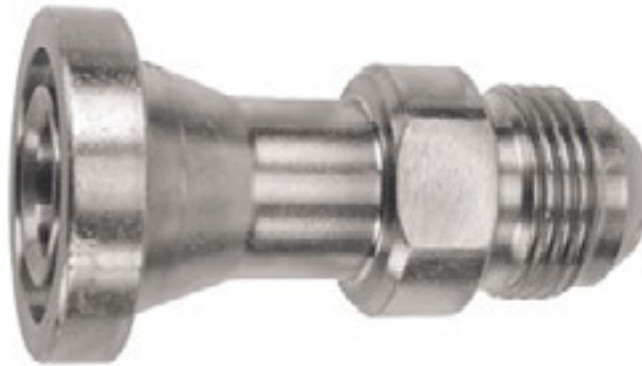

Description	Part Number
ADAPTER, #12 C62 FLG X #12 MJIC STR	0915H-12-12
ADAPTER, #12 C62 FLG X #16 MJIC STR	0915H-12-16
ADAPTER, #16 C62 FLG X #12 MJIC STR	0915H-16-12
ADAPTER, #16 C62 FLG X #16 MJIC STR	0915H-16-16

## 14.2.1 HYDRAULIC FITTINGS ADAPTERS 45 - JIC



Description	Part Number
ADAPTER, #4 JIC 45 M/F	0545-04-04
ADAPTER, #6 JIC 45 M/F	0545-06-06
ADAPTER, #8 JIC 45 M/F	0545-08-08
ADAPTER, #10 JIC 45 M/F	0545-10-10
ADAPTER, #12 JIC 45 M/F	0545-12-12
ADAPTER, #16 JIC 45 M/F	0545-16-16
ADAPTER, #20 JIC 45 M/F	0545-20-20

## 14.2.2 HYDRAULIC FITTINGS ADAPTERS 45 - JIC TO NPT



Description	Part Number
ADAPTER, 1/8" NPT X #4 JIC 45	1546-02-04
ADAPTER, 1/4" NPT X #4 JIC 45	1546-04-04
ADAPTER, 3/8" NPT X #6 JIC 45	1546-06-06
ADAPTER, 1/2" NPT X #8 JIC 45	1546-08-08
ADAPTER, 3/4" NPT X #12 JIC 45	1546-12-12
ADAPTER, 1" NPT X #16 JIC 45	1546-16-16
ADAPTER, 1-1/4" NPT X #20 JIC 45	1546-20-20

### 14.2.3 HYDRAULIC FITTINGS ADAPTERS 45 - JIC TO ORB



Description	Part Number
ADAPTER, #4 ORB X #4 JIC 45	1145-04-04
ADAPTER, #6 ORB X #6 JIC 45	1145-06-06
ADAPTER, #8 ORB X #6 JIC 45	1145-08-06
ADAPTER, #8 ORB X #8 JIC 45	1145-08-08
ADAPTER, #12 ORB X #12 JIC 45	1145-12-12

### 14.2.3 HYDRAULIC FITTINGS ADAPTERS 45 - JIC TO ORB



Description	Part Number
ADAPTER, #16 ORB X #16 JIC 45	1145-16-16
ADAPTER, #20 ORB X #16 JIC 45	1145-20-16
ADAPTER, #20 ORB X #20 JIC 45	1145-20-20

## 14.2.4 HYDRAULIC FITTINGS ADAPTERS 45 - MALE JIC TO FLANGE



Description	Part Number
ADAPTER, #16 C61 FLG X #12 MJIC 45	0945-16-12
ADAPTER, #16 C61 FLG X #16 MJIC 45	0945-16-16

## 14.2.4 HYDRAULIC FITTINGS ADAPTERS 45 - MALE JIC TO FLANGE



Description	Part Number
ADAPTER, #12 C62 FLG X #12 MJIC 45	0945H-12-12
ADAPTER, #12 C62 FLG X #16 MJIC 45	0945H-12-16
ADAPTER, #16 C62 FLG X #16 MJIC 45	0945H-16-16

### 14.3.1 HYDRAULIC FITTINGS ADAPTERS 90 - JIC



Description	Part Number
ADAPTER, #4 JIC 90 M/F	0595-04-04
ADAPTER, #6 JIC 90 M/F	0595-06-06
ADAPTER, #8 JIC 90 M/F	0595-08-08
ADAPTER, #10 JIC 90 M/F	0595-10-10
ADAPTER, #12 JIC 90 M/F	0595-12-12
ADAPTER, #16 JIC 90 M/F	0595-16-16
ADAPTER, #20 JIC 90 M/F	0595-20-20

## 14.3.2 HYDRAULIC FITTINGS ADAPTERS 90 - JIC TO NPT



Description	Part Number
ADAPTER, 1/8" NPT X #4 JIC 90	1596-02-04
ADAPTER, 1/4" NPT X #4 JIC 90	1596-04-04
ADAPTER, 1/4" NPT X #6 JIC 90	1596-04-06
ADAPTER, 3/8" NPT X #4 JIC 90	1596-06-04
ADAPTER, 3/8" NPT X #6 JIC 90	1596-06-06
ADAPTER, 3/8" NPT X #8 JIC 90	1596-06-08
ADAPTER, 1/2" NPT X #6 JIC 90	1596-08-06
ADAPTER, 1/2" NPT X #8 JIC 90	1596-08-08

## 14.3.2 HYDRAULIC FITTINGS ADAPTERS 90 - JIC TO NPT



Description	Part Number
ADAPTER, 1/2" NPT X #10 JIC 90	1596-08-10
ADAPTER, 3/4" NPT X #6 JIC 90	1596-12-06
ADAPTER, 3/4" NPT X #8 JIC 90	1596-12-08
ADAPTER, 3/4" NPT X #12 JIC 90	1596-12-12
ADAPTER, 3/4" NPT X #16 JIC 90	1596-12-16
ADAPTER, 1" NPT X #8 JIC 90	1596-16-08
ADAPTER, 1" NPT X #12 JIC 90	1596-16-12
ADAPTER, 1" NPT X #16 JIC 90	1596-16-16
ADAPTER, 1" NPT X #20 JIC 90	1596-16-20
ADAPTER, 1-1/4" NPT X #16 JIC 90	1596-20-16
ADAPTER, 1-1/4" NPT X #20 JIC 90	1596-20-20
ADAPTER, 1-1/2" NPT X #20 JIC 90	1596-24-20
ADAPTER, 1-1/2" NPT X #24 JIC 90	1596-24-24

### 14.3.3 HYDRAULIC FITTINGS ADAPTERS 90 - JIC TO ORB



Description	Part Number	Description	Part Number
ADAPTER, #4 ORB X #4 JIC 90	1195-04-04	ADAPTER, #8 ORB X #8 JIC 90	1195-08-08
ADAPTER, #4 ORB X #6 JIC 90	1195-04-06	ADAPTER, #8 ORB X #10 JIC 90	1195-08-10
ADAPTER, #5 ORB X #4 JIC 90	1195-05-04	ADAPTER, #8 ORB X #12 JIC 90	1195-08-12
ADAPTER, #5 ORB X #6 JIC 90	1195-05-06	ADAPTER, #10 ORB X #6 JIC 90	1195-10-06
ADAPTER, #6 ORB X #4 JIC 90	1195-06-04	ADAPTER, #10 ORB X #8 JIC 90	1195-10-08
ADAPTER, #6 ORB X #6 JIC 90	1195-06-06	ADAPTER, #10 ORB X #10 JIC 90	1195-10-10
ADAPTER, #6 ORB X #8 JIC 90	1195-06-08	ADAPTER, #10 ORB X #12 JIC 90	1195-10-12
ADAPTER, #8 ORB X #4 JIC 90	1195-08-04	ADAPTER, #12 ORB X #6 JIC 90	1195-12-06
ADAPTER, #8 ORB X #6 JIC 90	1195-08-06	ADAPTER, #12 ORB X #8 JIC 90	1195-12-08

### 14.3.3 HYDRAULIC FITTINGS ADAPTERS 90 - JIC TO ORB



Description	Part Number
ADAPTER, #12 ORB X #10 JIC 90	1195-12-10
ADAPTER, #12 ORB X #12 JIC 90	1195-12-12
ADAPTER, #12 ORB X #16 JIC 90	1195-12-16
ADAPTER, #16 ORB X #8 JIC 90	1195-16-08
ADAPTER, #16 ORB X #12 JIC 90	1195-16-12
ADAPTER, #16 ORB X #16 JIC 90	1195-16-16
ADAPTER, #16 ORB X #20 JIC 90	1195-16-20
ADAPTER, #20 ORB X #12 JIC 90	1195-20-12
ADAPTER, #20 ORB X #16 JIC 90	1195-20-16
ADAPTER, #20 ORB X #20 JIC 90	1195-20-20
ADAPTER, #20 ORB X #24 JIC 90	1195-20-24
ADAPTER, #24 ORB X #20 JIC 90	1195-24-20
ADAPTER, #24 ORB X #24 JIC 90	1195-24-24

## 14.4.1 HYDRAULIC FITTINGS BULKHEADS - JIC

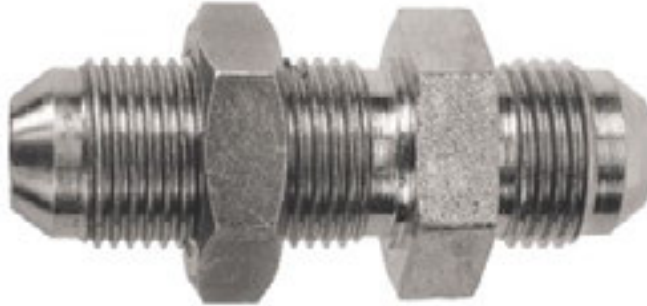

Description	Part Number
ADAPTER, #4 JIC BULKHEAD	1515BH-04-04
ADAPTER, #6 JIC BULKHEAD	1515BH-06-06
ADAPTER, #8 JIC BULKHEAD	1515BH-08-08
ADAPTER, #12 JIC BULKHEAD	1515BH-12-12
ADAPTER, #16 JIC BULKHEAD	1515BH-16-16
ADAPTER, #20 JIC BULKHEAD	1515BH-20-20
ADAPTER, #24 JIC BULKHEAD	1515BH-24-24

## 14.4.2 HYDRAULIC FITTINGS BULKHEADS - JIC TO FNPT

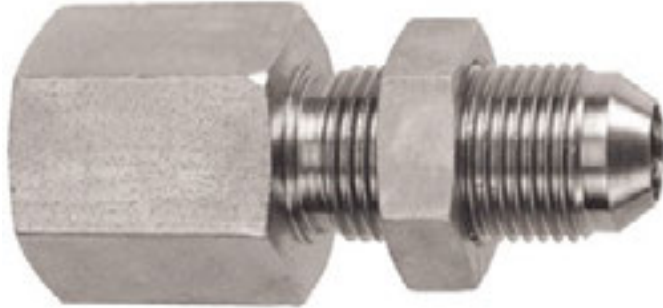

Description	Part Number
BULKHEAD, 1/4" FNPT X #4 JIC	1508BH-04-04
BULKHEAD, 3/8" FNPT X #6 JIC	1508BH-06-06
BULKHEAD, 1/2" FNPT X #8 JIC	1508BH-08-08
BULKHEAD, 3/4" FNPT X #12 JIC	1508BH-12-12
BULKHEAD, 1" FNPT X #16 JIC	1508BH-16-16

### 14.4.3 HYDRAULIC FITTINGS BULKHEADS - JIC TO NPT



Description	Part Number
BULKHEAD, 1/4" NPT X #4 JIC	1516BH-04-04
BULKHEAD, 1/4" NPT X #6 JIC	1516BH-04-06
BULKHEAD, 3/8" NPT X #6 JIC	1516BH-06-06
BULKHEAD, 1/2" NPT X #8 JIC	1516BH-08-08
BULKHEAD, 3/4" NPT X #12 JIC	1516BH-12-12
BULKHEAD, 1" NPT X #16 JIC	1516BH-16-16
BULKHEAD, 1-1/4" NPT X #20 JIC	1516BH-20-20

## 14.5.1 HYDRAULIC FITTINGS BULKHEADS 90 - JIC



Description	Part Number
ADAPTER, #4 JIC 90 BULKHEAD	1595BH-04-04
ADAPTER, #6 JIC 90 BULKHEAD	1595BH-06-06
ADAPTER, #8 JIC 90 BULKHEAD	1595BH-08-08
ADAPTER, #12 JIC 90 BULKHEAD	1595BH-12-12
ADAPTER, #16 JIC 90 BULKHEAD	1595BH-16-16
ADAPTER, #20 JIC 90 BULKHEAD	1595BH-20-20

## 14.6.1 HYDRAULIC FITTINGS BUSHINGS - FNPT TO NPT



Description	Part Number
BUSHING, 1/4" NPT X 1/8" FNPT	0816-04-02
BUSHING, 3/8" NPT X 1/4" FNPT	0816-06-04
BUSHING, 1/2" NPT X 1/8" FNPT	0816-08-02
BUSHING, 1/2" NPT X 1/4" FNPT	0816-08-04
BUSHING, 1/2" NPT X 3/8" FNPT	0816-08-06
BUSHING, 3/4" NPT X 1/4" FNPT	0816-12-04
BUSHING, 3/4" NPT X 3/8" FNPT	0816-12-06
BUSHING, 3/4" NPT X 1/2" FNPT	0816-12-08
BUSHING, 1" NPT X 1/4" FNPT	0816-16-04
BUSHING, 1" NPT X 3/8" FNPT	0816-16-06
BUSHING, 1" NPT X 1/2" FNPT	0816-16-08
BUSHING, 1" NPT X 3/4" FNPT	0816-16-12

## 14.6.1 HYDRAULIC FITTINGS BUSHINGS - FNPT TO NPT



Description	Part Number
BUSHING, 1-1/4" NPT X 1/2" FNPT	0816-20-08
BUSHING, 1-1/4" NPT X 3/4" FNPT	0816-20-12
BUSHING, 1-1/4" NPT X 1" FNPT	0816-20-16
BUSHING, 1-1/2" NPT X 1-1/4" FNPT	0816-24-20

## 14.7.1 HYDRAULIC FITTINGS COUPLINGS - FNPT

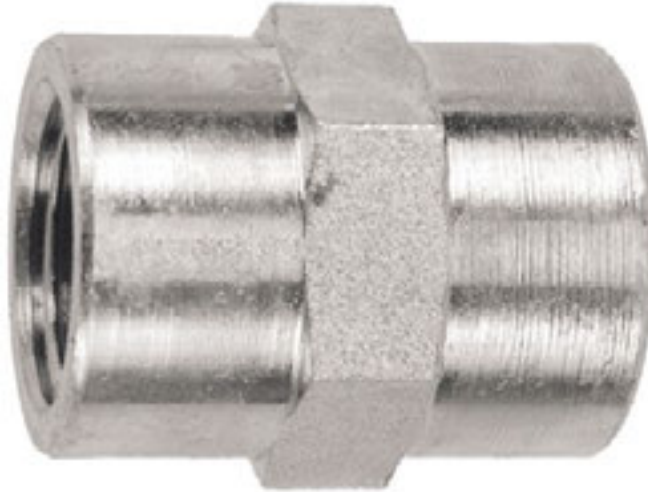

Description	Part Number
COUPLING, 1/8" FNPT	0808-02-02
COUPLING, 1/4" FNPT	0808-04-04
COUPLING, 3/8" FNPT	0808-06-06
COUPLING, 1/2" FNPT	0808-08-08
COUPLING, 3/4" FNPT	0808-12-12
COUPLING, 1" FNPT	0808-16-16
COUPLING, 1-1/4" FNPT	0808-20-20

## 14.8.1 HYDRAULIC FITTINGS ELBOWS 90 - JIC



Description	Part Number
ELBOW ADAPTER, #12 90 JIC	50045412



Description	Part Number
ELBOW ADAPTER, #16 90 JIC	50045416

### 14.8.1 HYDRAULIC FITTINGS ELBOWS 90 - JIC



Description	Part Number
ELBOW ADAPTER, #6 90 JIC	5004546



Description	Part Number
ELBOW ADAPTER, #8 90 JIC	5004548

### 14.8.1 HYDRAULIC FITTINGS ELBOWS 90 - JIC



Description	Part Number
ELBOW, #12 JIC M X F LONG DROP 90	50409512



Description	Part Number
ELBOW, #16 JIC M X F 90	50409516

### 14.8.1 HYDRAULIC FITTINGS ELBOWS 90 - JIC



Description	Part Number
ELBOW, #20 JIC M X F90	50409520



Description	Part Number
ELBOW, #6 JIC M X F 90	5040956

# 14.8.1 HYDRAULIC FITTINGS ELBOWS 90 - JIC



Description	Part Number
ELBOW, #8 JIC M X F 90	5040958

## 14.8.2 HYDRAULIC FITTINGS ELBOWS 90 - FNPT



Description	Part Number
ELBOW, 1/8" FNPT 90	0898-02-02
ELBOW, 1/4" FNPT 90	0898-04-04
ELBOW, 3/8" FNPT 90	0898-06-06
ELBOW, 1/2" FNPT 90	0898-08-08
ELBOW, 3/4" FNPT 90	0898-12-12
ELBOW, 1" FNPT 90	0898-16-16

### 14.8.3 HYDRAULIC FITTINGS ELBOWS 90 - FNPT TO NPT



Description	Part Number
ELBOW, 1/8" NPT X 1/8" FNPT 90	1698-02-02
ELBOW, 1/4" NPT X 1/4" FNPT 90	1698-04-04
ELBOW, 3/8" NPT X 3/8" FNPT 90	1698-06-06
ELBOW, 1/2" NPT X 1/2" FNPT 90	1698-08-08
ELBOW, 1/2" NPT X 3/4" FNPT 90	1698-08-12
ELBOW, 3/4" NPT X 3/4" FNPT 90	1698-12-12
ELBOW, 1" NPT X 1" FNPT 90	1698-16-16
ELBOW, 1-1/4" NPT X 1-1/4" FNPT 90	1698-20-20

## 14.8.4 HYDRAULIC FITTINGS ELBOWS 90 - NPT



Description	Part Number
ELBOW, 1/8" NPT 90	1696-02-02
ELBOW, 1/4" NPT 90	1696-04-04
ELBOW, 3/8" NPT 90	1696-06-06
ELBOW, 1/2" NPT 90	1696-08-08
ELBOW, 3/4" NPT 90	1696-12-12
ELBOW, 1" NPT 90	1696-16-16
ELBOW, 1-1/4" NPT 90	1696-20-20

## 14.8.5 HYDRAULIC FITTINGS ELBOWS 90 - MALE JIC TO FLANGE



Description	Part Number
ADAPTER, #12 C61 FLG X #12 MJIC 90	0995-12-12
ADAPTER, #12 C61 FLG X #16 MJIC 90	0995-12-16
ADAPTER, #16 C61 FLG X #12 MJIC 90	0995-16-12
ADAPTER, #16 C61 FLG X #16 MJIC 90	0995-16-16
ADAPTER, #20 C61 FLG X #12 MJIC 90	0995-20-12
ADAPTER, #20 C61 FLG X #16 MJIC 90	0995-20-16

## 14.8.5 HYDRAULIC FITTINGS ELBOWS 90 - MALE JIC TO FLANGE



Description	Part Number
ADAPTER, #12 C62 FLG X #12 MJIC 90	0995H-12-12
ADAPTER, #12 C62 FLG X #16 MJIC 90	0995H-12-16
ADAPTER, #16 C62 FLG X #16 MJIC 90	0995H-16-16

## 14.9.1 HYDRAULIC FITTINGS NIPPLES - NPT

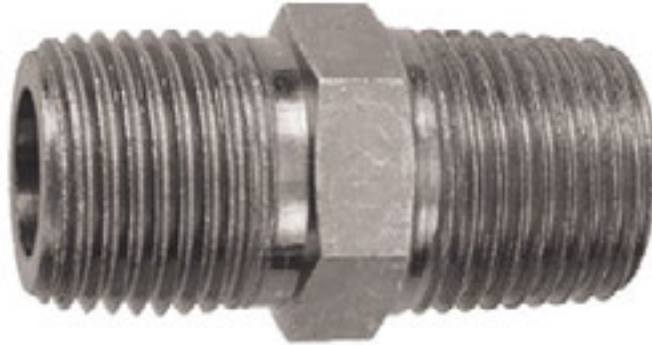

Description	Part Number
HEX NIPPLE, 1/8" NPT	1616-02-02
HEX NIPPLE, 1/4" NPT	1616-04-04
HEX NIPPLE, 3/8" NPT	1616-06-06
HEX NIPPLE, 1/2" X 3/8" NPT	1616-08-06
HEX NIPPLE, 1/2" NPT	1616-08-08
HEX NIPPLE, 3/4" NPT	1616-12-12
HEX NIPPLE, 1" X 3/4" NPT	1616-16-12
HEX NIPPLE, 1" NPT	1616-16-16
HEX NIPPLE, 1-1/4" NPT	1616-20-20
HEX NIPPLE, 1-1/2" NPT	1616-24-24

## 14.10.1 HYDRAULIC FITTINGS REDUCERS - ORB TO FORB



Description	Part Number
REDUCER, #6 ORB X #4 FORB	0111-06-04
REDUCER, #8 ORB X #6 FORB	0111-08-06
REDUCER, #12 ORB X #8 FORB	0111-12-08
REDUCER, #16 ORB X #12 FORB	0111-16-12
REDUCER, #20 ORB X #12 FORB	0111-20-12
REDUCER, #20 ORB X #16 FORB	0111-20-16
REDUCER, #24 ORB X #20 FORB	0111-24-20

## 14.11.1 HYDRAULIC FITTINGS TEES - JIC



Description	Part Number
FLARE FEMALE SWIVEL RUN TEE, #4 JIC	05T55-04-04
FLARE FEMALE SWIVEL RUN TEE, #6 JIC	05T55-06-06
FLARE FEMALE SWIVEL RUN TEE, #8 JIC	05T55-08-08
FLARE FEMALE SWIVEL RUN TEE, #10 JIC	05T55-10-10
FLARE FEMALE SWIVEL RUN TEE, #12 JIC	05T55-12-12
FLARE FEMALE SWIVEL RUN TEE, #16 JIC	05T55-16-16
FLARE FEMALE SWIVEL RUN TEE, #20 JIC	05T55-20-20

## 14.11.1 HYDRAULIC FITTINGS TEES - JIC



Description	Part Number
BRANCH TEE, #4 JIC	15T505-04-04
BRANCH TEE, #6 JIC	15T505-06-06
BRANCH TEE, #8 JIC	15T505-08-08
BRANCH TEE, #12 JIC	15T505-12-12
BRANCH TEE, #16 JIC	15T505-16-16
BRANCH TEE, #20 JIC	15T505-20-20

## 14.11.1 HYDRAULIC FITTINGS TEES - JIC



Description	Part Number
TEE, #4 JIC	15T55-04-04
TEE, #6 JIC	15T55-06-06
TEE, #8 JIC	15T55-08-08
TEE, #12 JIC	15T55-12-12
TEE, #16 JIC	15T55-16-16
TEE, #20 JIC	15T55-20-20

## 14.11.2 HYDRAULIC FITTINGS TEES - JIC TO NPT



Description	Part Number
BRANCH TEE, #4 JIC X 1/4" NPT	15T56-04-04
BRANCH TEE, #6 JIC X 3/8" NPT	15T56-06-06
BRANCH TEE, #8 JIC X 1/2" NPT	15T56-08-08
BRANCH TEE, #12 JIC X 3/4" NPT	15T56-12-12
BRANCH TEE, #16 JIC X 1" NPT	15T56-16-16
BRANCH TEE, #20 JIC X 1-1/4" NPT	15T56-20-20

## 14.11.2 HYDRAULIC FITTINGS TEES - JIC TO NPT



Description	Part Number
RUN TEE, #4 JIC X 1/4" NPT	15T65-04-04
RUN TEE, #6 JIC X 3/8" NPT	15T65-06-06
RUN TEE, #8 JIC X 1/2" NPT	15T65-08-08
RUN TEE, #12 JIC X 3/4" NPT	15T65-12-12
RUN TEE, #16 JIC X 1" NPT	15T65-16-16
RUN TEE, #20 JIC X 1-1/4" NPT	15T65-20-20

### 14.11.3 HYDRAULIC FITTINGS TEES - JIC TO ORB



Description	Part Number
RUN TEE, #4 JIC X #4 ORB	11T55-04-04
RUN TEE, #6 JIC X #6 ORB	11T55-06-06
RUN TEE, #8 JIC X #8 ORB	11T55-08-08
RUN TEE, #12 JIC X #12 ORB	11T55-12-12

### 14.11.3 HYDRAULIC FITTINGS TEES - JIC TO ORB



Description	Part Number
RUN TEE, #16 JIC X #16 ORB	11T55-16-16
RUN TEE, #20 JIC X #20 ORB	11T55-20-20

### 14.11.3 HYDRAULIC FITTINGS TEES - JIC TO ORB



Description	Part Number
BRANCH TEE, #4 JIC X #4 ORB	15T51-04-04
BRANCH TEE, #6 JIC X #6 ORB	15T51-06-06
BRANCH TEE, #8 JIC X #8 ORB	15T51-08-08
BRANCH TEE, #12 JIC X #12 ORB	15T51-12-12
BRANCH TEE, #16 JIC X #16 ORB	15T51-16-16
BRANCH TEE, #20 JIC X #20 ORB	15T51-20-20

## 14.11.4 HYDRAULIC FITTINGS TEES - NPT



Description	Part Number
BRANCH TEE, 1/4" NPT	08T86-04-04
BRANCH TEE, 3/8" NPT	08T86-06-06
BRANCH TEE, 1/2" NPT	08T86-08-08
BRANCH TEE, 3/4" NPT	08T86-12-12
BRANCH TEE, 1" NPT	08T86-16-16
BRANCH TEE, 1-1/4" NPT	08T86-20-20

## 14.11.4 HYDRAULIC FITTINGS TEES - NPT



Description	Part Number
RUN TEE, 1/4" NPT	16T88-04-04
RUN TEE, 3/8" NPT	16T88-06-06
RUN TEE, 1/2" NPT	16T88-08-08
RUN TEE, 3/4" NPT	16T88-12-12
RUN TEE, 1" NPT	16T88-16-16

## 14.12.1 HYDRAULIC FITTINGS UNIONS - JIC

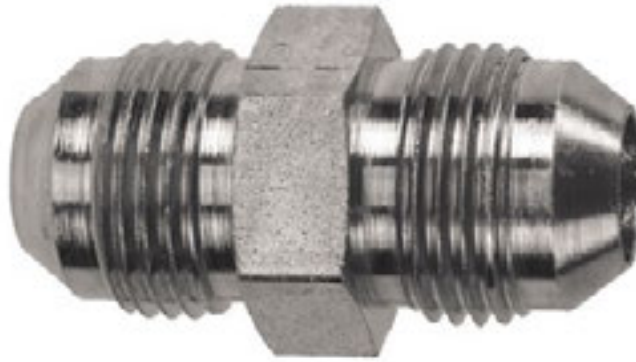

Description	Part Number
UNION, #4 JIC	1515-04-04
UNION, #6 JIC	1515-06-06
UNION, #8 JIC X #6 JIC	1515-08-06
UNION, #8 JIC	1515-08-08
UNION, #10 JIC X #8 JIC	1515-10-08
UNION, #12 JIC	1515-12-12
UNION, #16 JIC	1515-16-16

## 15.0 ALUMINUM SLIDE-IN TANKS



### Standard Unit:

- 300gal Waste / 150gal Fresh
- Electric start 160 CC Honda – Conde Super 6 pump
- Belt Drive
- 70 C.F.M.
- 12 Volt wash down pump with 50ft hose
- 30' x 2" Tiger Tail inlet hose w/stinger
- Work light

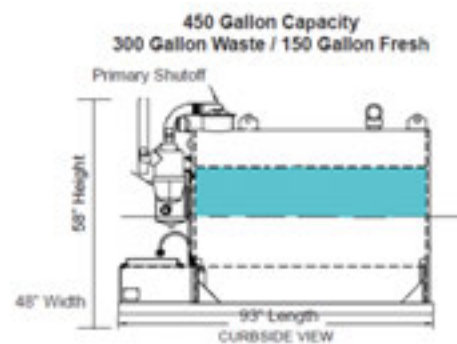

160cc Masport HXL2V – 76 C.F.M.  
270cc Conde SDS 6, belt drive – 115 C.F.M.  
270cc Masport HXL – 3V direct drive – 106 C.F.M.  
390cc Masport HXL – 4V belt drive – 165 C.F.M.  
390cc Conde SDS 12, belt drive – 180 C.F.M.

300 Gallon (200 waste / 100 fresh) – O.A.L. 73"  
600 Gallon (400 waste / 200 fresh) – O.A.L. 113" (46" Dia.)  
800 Gallon (540 waste / 260 fresh) – O.A.L. 113" (54" Dia.)  
995 Gallon (670 waste / 325 fresh) – O.A.L. 113" (60" Dia.)  
Vacuum Only (No Fresh) All Sizes

**ALUMINUM SLIDE IN  
SPEC SHEET FOR**

## STANDARD SIZES

	WIDTH	HEIGHT	LENGTH	AS WEIGHED
300 GALLON	47"	58"	73"	Approx. 725
300 crated	62"	65"	100"	
450 GALLON	47"	58"	93"	Approx. 820
450 crated	62"	65"	100"	
600 GALLON	51"	58"	113"	Approx. 980
600 crated	62"	65"	124"	
600 SPECIAL	59"	66"	93"	Approx. 980
600 SP crated	74"	73"	100"	
800 GALLON	59"	66"	113"	Approx. 1120
800 crated	74"	73"	124"	
995 GALLON	65"	72"	113"	Approx. 1220
995 crated	74"	79"	124"	

### NOTES:

- MAXIMUM VACUUM 18 HG, MAXIMUM PRESSURE 7PSIG
- WEIGHTS WILL VARY FOR VACUUM ONLY UNITS TO UNITS WITH FRESH WATER FILL
- HOSE HOOKS ADD 7" TO THE WIDTH BUT ARE MOUNTED ABOVE PICKUP BOX LEVEL
- A 54" DIAMETER TANK WILL EASILY FIT BETWEEN THE WHEEL WELLS IN A STANDARD PICKUP BED
- THE LENGTH SHOWN IS THE LENGTH OF THE 6" X 3" FRAME RAIL
- IT MAY BE POSSIBLE TO BUILD A LARGER DIAMETER TANK IN ORDER TO REDUCE THE OVERALL LENGTH
- PUMP PLATFORM APPROX 28" LONG
- 3" DISCHARGE
- SOME OF THE LARGER PUMPS WILL HANG OVER THE PLATFORM AND ADD AN ADDITIONAL 3" TO THE OVERALL LENGTH
- 20" MANWAY IS 1 ¾" TALLER THAN PRIMARY SCRUBBER (DISTANCE FROM BOTTOM OF LUG BRACKET TO TOP OF COVER)
- CONDE WEIGHTS; SUPER 6 – 160 LBS, SDS6 – 200 LBS, SDS12 – 275 LBS

